



Protection - Control - Identification - Tracking - Rfid solutions

www.leghorngroup.com

Plastic lead seals:
Plombex



Pliers



Sealing wires

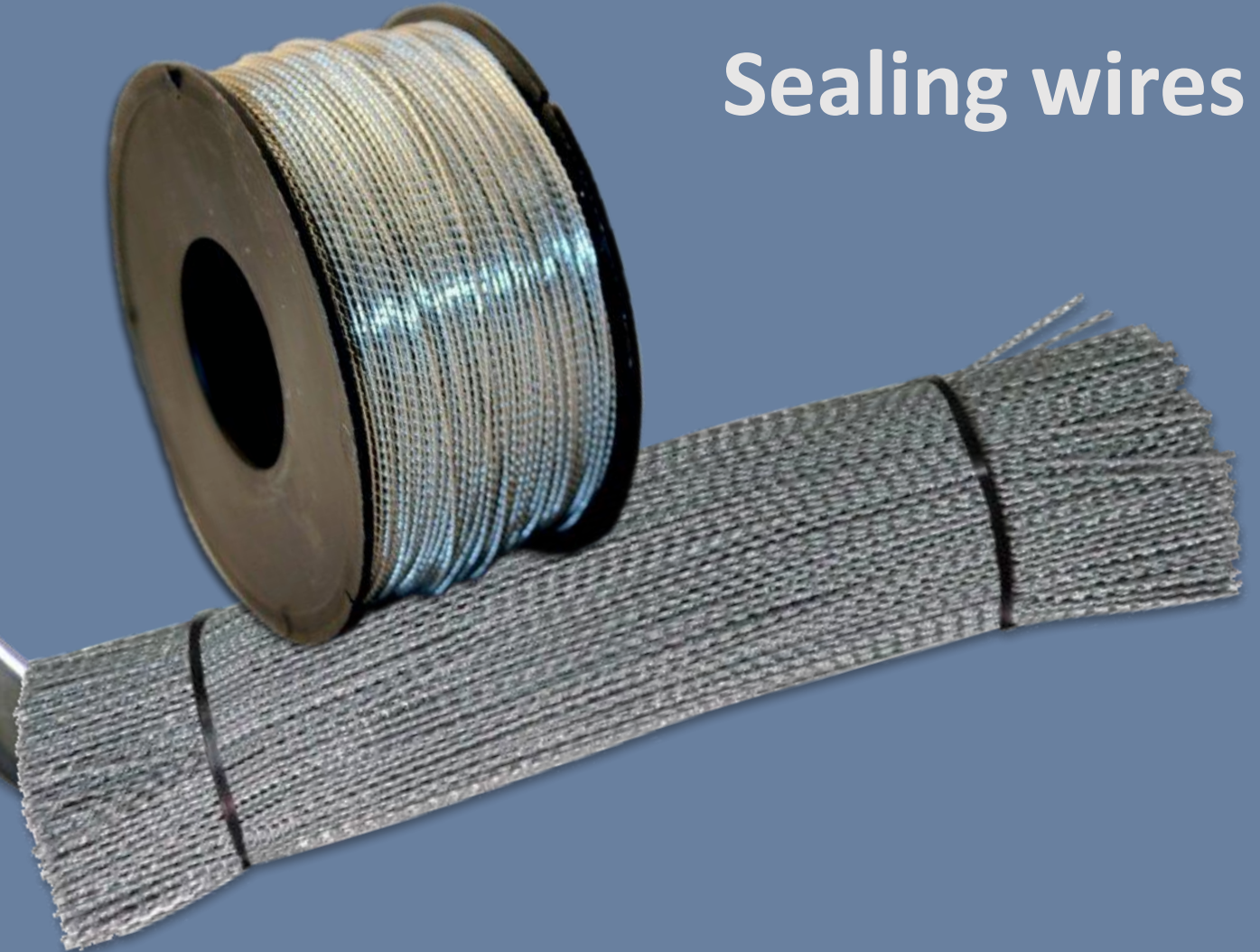

Stainless steel sealing wire

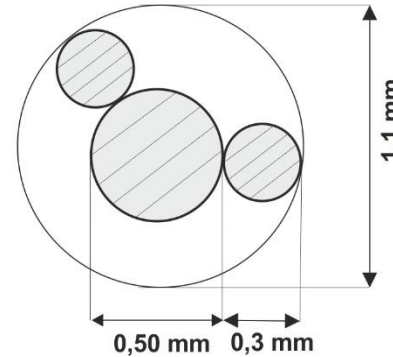
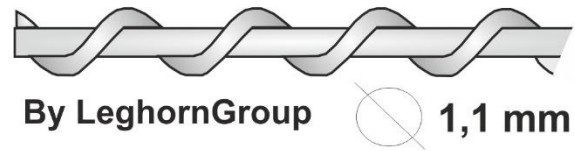

Product description:

- Annealed steel AISI 304
- Core wire: \varnothing mm 0.50
- Spiral wire: \varnothing mm 0.30
- Total diameter 1mm
- Standard spools: 1 kg – 400 m approx
- Standard spools: 0.5kg – 200 m approx

Packaging:

(both for 1kg and 0.5kg spools)

- Carton with 24 kg
- Carton size: 40x30x20 cm
- Carton weight: 24kg
- Pallet: 80x120x95 cm, 768 kg

Galvanised steel sealing wire

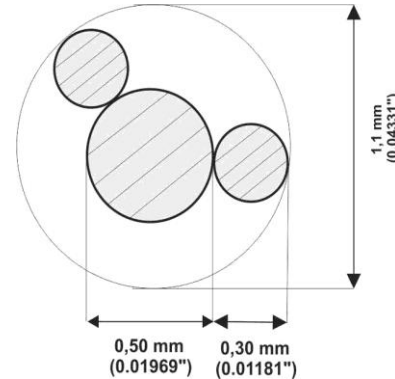
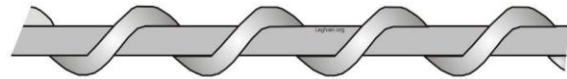

Product description:

- Galvanised annealed steel
- Core wire: \varnothing mm 0.50
- Spiral wire: \varnothing mm 0.30
- Total diameter 1mm
- Standard spools: 1 kg – 400 m approx
- Standard spools: 0.5kg – 200 m approx

Packaging:

(both for 1kg and 0.5kg spools)

- Carton with 24 kg
- Carton size: 40x30x20 cm
- Carton weight: 24kg
- Pallet: 80x120x95 cm, 768 kg

Copper sealing wire

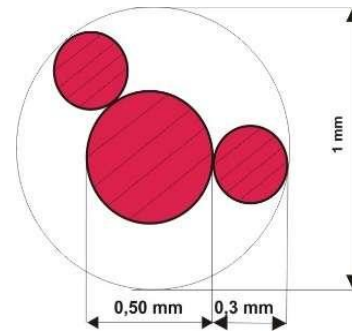

Product description:

- Red copper annealed ASTM B 49,92 – UNI EN 1977 - 2000
- Core wire: \varnothing mm 0.50
- Spiral wire: \varnothing mm 0.30
- Total diameter 1mm
- Standard spools: 1 kg – 360 m approx
- Standard spools: 0.5 kg – 180 m approx

Packaging:

(both for 1kg and 0.5kg spools)

- Carton with 24 kg
- Carton size: 40x30x20 cm
- Carton weight: 24kg
- Pallet: 80x120x95 cm, 768 kg

Brass sealing wire

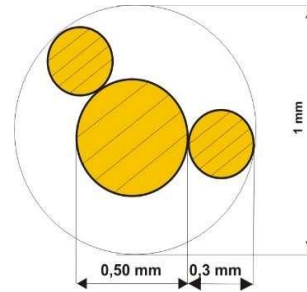
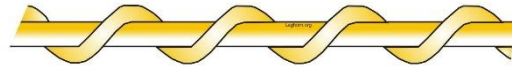

Product description:

- Brass annealed
- Core wire: \varnothing mm 0.50
- Spiral wire: \varnothing mm 0.30
- Total diameter: 1mm
- Standard spools: 1 kg – 380 m approx
- Standard spools: 0.5kg – 190 m approx

Packaging:

(both for 1kg and 0.5kg spools)

- Carton with 24 kg
- Carton size: 40x30x20 cm
- Carton weight: 24kg
- Pallet: 80x120x95 cm, 768 kg

Nylon-copper sealing wire

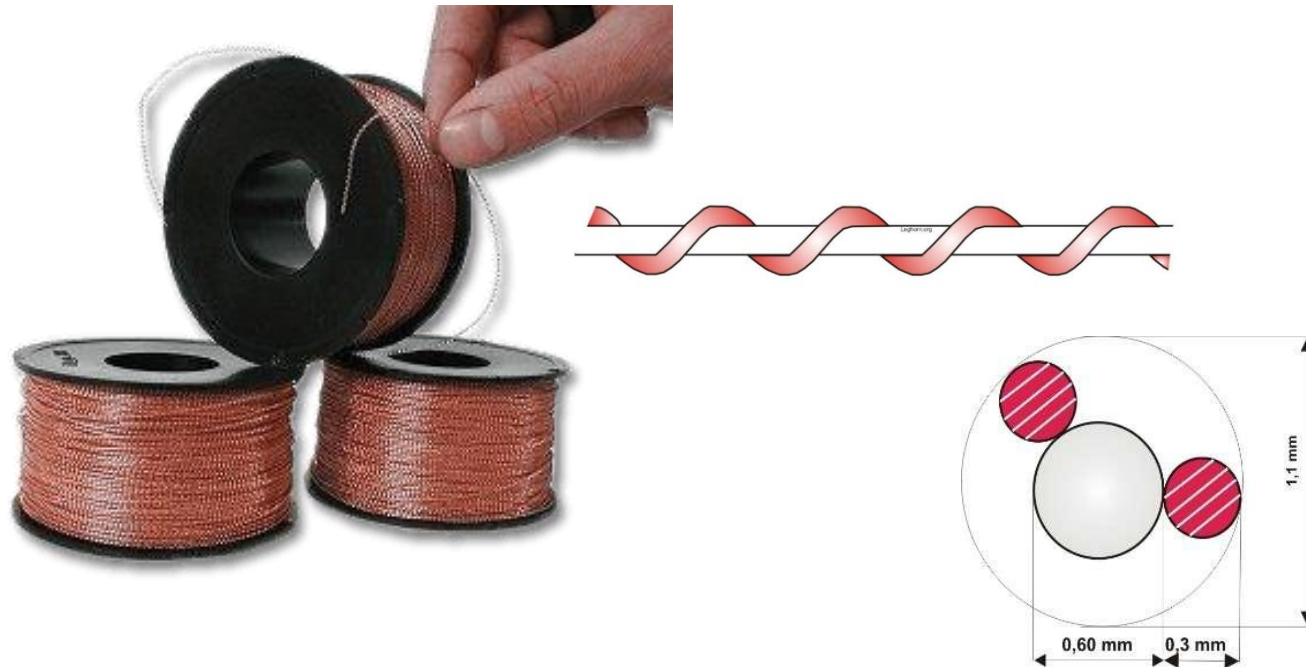

Product description:

- Nylon copper
- Core wire: \varnothing mm 0.60 - 100% Polyamide
- Spiral wire red annealed: \varnothing mm 0.30 according to ASTM 49,92 - UNI EN 1977 - 2000
- Total diameter: 1mm
- Standard spools: 300gr– 180 m approx

Packaging:

- Carton with 36 spools – each spool 0.3kg
- Carton size: 40x30x18cm
- Carton weight: 11.20 kg
- Pallet: 80x120x95cm, 1152 spools

Plastic coated stainless steel cable

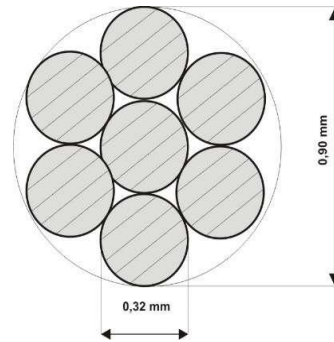
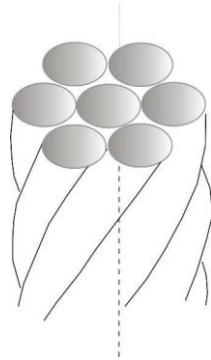

Product description:

- Seven stainless steel wire + PVC transparent plastic covered.
- Core diameter (stainless) \varnothing mm 0.32
- Total diameter: 1mm
- Standard spools: 100 m – 406 gr approx
- Standard spools: 250 m – 675 gr approx

Packaging:

- Carton with 20 spools of 250m
- Carton size: 40x24x17cm
- Carton weight: 15kg
- Pallet: 80x120x111cm, 500kg, 640 spools

Lead seals pliers

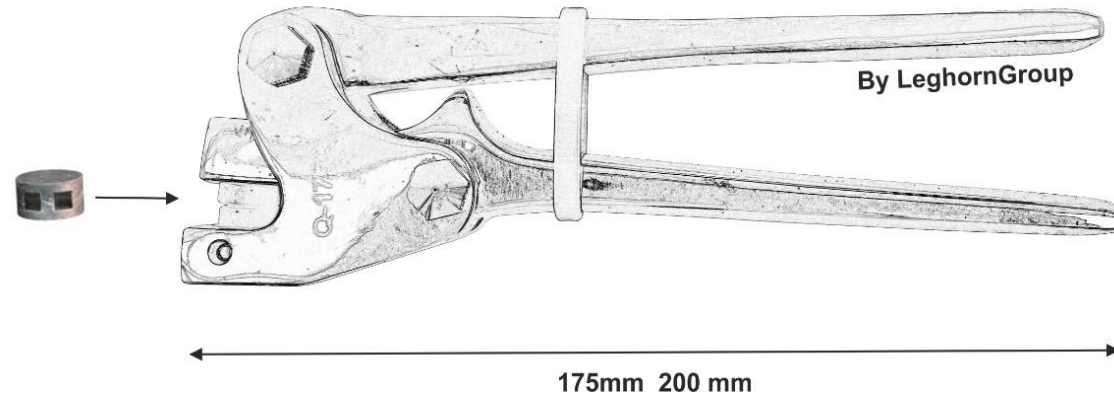

MISURE:

ART 464/175 e 466/175: Length : 175 mm

ART 464/200 e 466/220: Length : 200 mm

Art 464/175 : for seals up to 12 mm diameter

Art 464/200 : for seals up to 15 mm diameter

Art 466/175 : for seals up to 12 mm diameter

Art 466/200 : for seals up to 15 mm diameter

Plastic lead seals: Plombex 9 mm

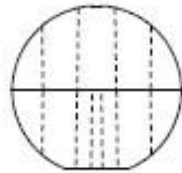
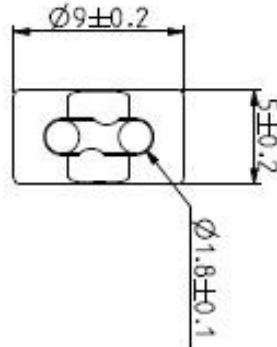

Product description:

- Shock-resistant polystyrene
- Suitable to be used with different sealing wires and appropriate pliers for the correct closure are required
- Diameter: 9mm
- Customisation with appropriate pliers
- Available colours: orange, silver, ivory, white, blue, yellow, grey, black, brown, red and green
- Further colours are available upon request

Packaging

- Carton with 10000 seals. Upon request, product available in plastic bags of 1000 seals
- Carton size: 27x22x11cm
- Carton weight: 2.8 kg
- Pallet: 80x120x145cm, 384 kg, 1300000 seals

Plastic lead seals: Plombex 13 mm

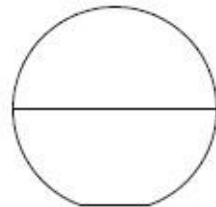
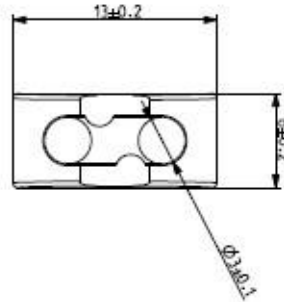

Product description:

- Shock-resistant polystyrene
- Suitable to be used with different sealing wires and appropriate pliers for the correct closure are required
- Diameter: 13mm
- Customisation with appropriate pliers
- Available colours: orange, silver, ivory, white, blue, yellow, grey, black, brown, red and green
- Further colours are available upon request

Packaging

- Carton with 10000 seals. Upon request, product available in plastic bags of 1000 seals
- Carton size: 40x24x17cm
- Carton weight: 5.6 kg
- Pallet: 80x120x175cm, 580 kg, 1000000 seals

Twistseal: wire seal with numbering

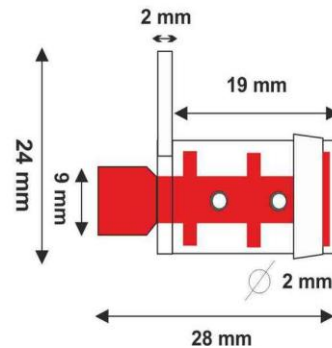
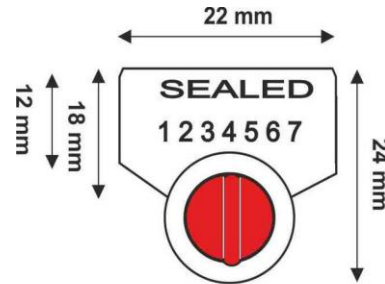
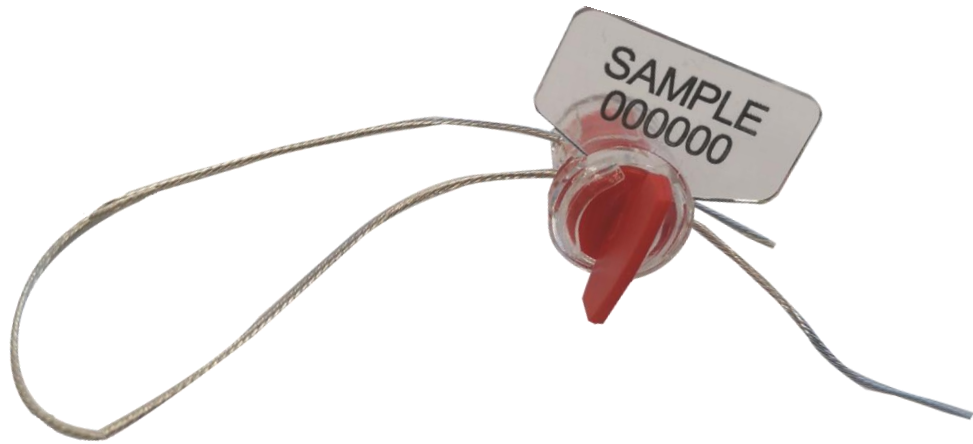

Product description:

- Polycarbonate and ABS seals
- Suitable to be used with different sealing wires and any pliers for the correct closure aren't required.
- Laser marking
- Progressive numbering up to 15 digits
- Barcode and company logo possibility
- Customisation up to 20 characters on one line
- Transparent or white body of the seal availability
- Working temperature: -30°C $+60^{\circ}\text{C}$
- Available flag colours: orange, light blue, white, yellow, red and green
- Further colours are available upon request

Flat tie – spools and pre-cut pieces

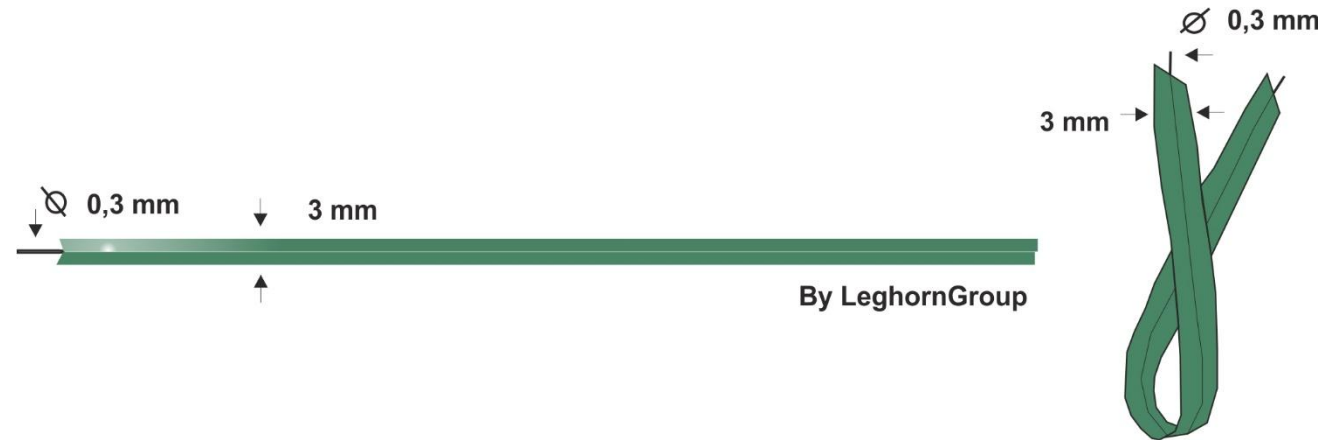

Available colours: green, black and white
Spools up to 5000 meters.
Upon request flat tie pre-cut pieces



Protection - Control - Identification - Tracking - Rfid solutions

www.leghorngroup.com

LeghornGroup presentation

For over 45 years now, LeghornGroup is a leading global manufacturer of security seals and electronic product and systems for identification, protection, control and tracking of goods and properties for different application.

The company has headquarters in Italy, seven subsidiaries worldwide, and owns two plastics and metal factories in Europe. LeghornGroup product portfolio with more than 120 items includes 19 models of high security seals compliant with ISO 17712:2013 – also passive RFID e-seals - and 46 plastic seals suitable for different application. LeghornGroup is at the forefront of manufacturing of sustainable seals with a wide range of 100% recyclable plastic seals, metal and electronic seals.

2023 LeghornGroup IT Team 7401-A680

Pictures and drawings are purely indicative. Sizes and colors are subject to change.



Protection - Control - Identification - Tracking - Rfid solutions

www.leghorngroup.com

FINDUS@

info@leghorngroup.com



LeghornGroup S.r.l.

34/36 Via degli Arrotini
57121 Livorno (LI) Italy
www.leghorngroup.com
info@leghorngroup.com

LeghornGroup – India
www.leghorngroup.in

LeghornGroup – Italy
www.leghorngroup.it

LeghornGroup – U.S.A.
www.leghorngroup.com

LeghornGroup – Belgium
www.leghorngroup.be
www.leghorngroup.nl

LeghornGroup – Czech Republic
www.leghorngroup.cz
www.leghorngroup.pl

LeghornGroup – Greece
www.leghorngroup.gr

LeghornGroup – Republic of
Moldova
www.leghorngroup.ro

LeghornGroup – España
www.leghorngroup.es

2023 LeghornGroup IT Team 7401-A680